

To install Kies (PC Sync) Kies

1. Download the latest version of Kies from the Samsung website (www.samsung.com/kies) and install it on your PC.
2. Using a PC data cable, connect your device to your PC. Samsung Kies will launch automatically. Refer to the Kies help for more information.

SAMSUNG

Samsung
GALAXY Tab
8.9

SGH-i957
user manual



Using this manual

Congratulations on your purchase of the Samsung P7500. This powerful, “go anywhere” device, puts the best of the web and mobile computing at your fingertips in a lightweight, highly versatile platform that fits your active lifestyle. Built on the Google Android operating system, the P7500 gives you access to thousands of useful and entertaining applications to enrich your mobile web experience.

With integrated wireless access and a responsive touch screen, you can read books and newspapers on the go; stay up-to-date on the latest news, sports, and weather; manage your multimedia and business files; and browse the web for maps, business locations, and more.

Read me first

- Please read all safety precautions and this manual carefully before using your device to ensure safe and proper use.
- The descriptions in this manual are based on the default settings of your device.
- Images and screenshots used in this user manual may differ in appearance from the actual product.
- Content in this user manual may differ from the product, or from software provided by service providers or carriers, and is subject to change without prior notice. Refer to www.samsung.com for the latest version of the user manual.
- Available features and additional services may vary by device, software, or service provider.

- Formatting and delivery of this user manual is based on Google Android operating systems and may vary depending on the user's operating system.
- Applications and their functions may vary by country, region, or hardware specifications. Samsung is not liable for performance issues caused by third-party applications.
- Samsung is not liable for performance issues or incompatibilities caused by user editing of registry settings.
- You may upgrade your mobile device's software by accessing www.samsung.ca.
- Sound sources, wallpapers, and images provided in this device are licenced for limited use between Samsung and their respective owners. Extracting and using these materials for commercial or other purposes is an infringement of copyright laws. Samsung is not liable for such copyright infringement by the user.
- Please keep this manual for future reference.

Instructional icons

Before you start, familiarize yourself with the icons you will see in this manual:



Warning—situations that could cause injury to yourself or others



Caution—situations that could cause damage to your device or other equipment



Note—notes, usage tips, or additional information

- ▶ **Refer to**—pages with related information; for example: ▶ p. 12 (represents “see page 12”)

- **Followed by**—the order of options or menus you must select to perform a step; for example: From the Home screen, open the application list and select **Settings** → **Wireless and networks** (represents **Settings**, followed by **Wireless and networks**)
- [] **Square brackets**—device keys; for example: [⓪] (represents the Power/Lock key)

Copyright

Copyright © 2011 Samsung Electronics Canada, Inc. SAMSUNG is a registered trademark of Samsung Electronics Co., Ltd. and its related entities.

This user manual is protected under international copyright laws.

No part of this user manual may be reproduced, distributed, translated, or transmitted in any form or by any means, electronic or mechanical, including photocopying, recording, or storing in any information storage and retrieval system, without the prior written permission of Samsung Electronics.

Trademarks



SAMSUNG and the SAMSUNG logo are registered trademarks of Samsung Electronics.

The Android logo, Google Search™, Google Maps™, Google Mail™, YouTube™, Android Market™, and Google Talk™ are trademarks of Google, Inc.

Bluetooth® is a registered trademark of the Bluetooth SIG, Inc. worldwide.

Oracle and Java are registered trademarks of Oracle and/or its affiliates. Other names may be trademarks of their respective owners.

Windows Media Player® is a registered trademark of Microsoft Corporation.

 and  are trademarks of SRS Labs, Inc. CS Headphone and WOW HD technologies are incorporated under licence from SRS Labs, Inc.

Wi-Fi®, the Wi-Fi CERTIFIED logo, and the Wi-Fi logo are registered trademarks of the Wi-Fi Alliance.

DivX®, DivX Certified® and associated logos are trademarks of Rovi Corporation or its subsidiaries and are used under license.

All other trademarks and copyrights are the property of their respective owners.

DivX Certified® to play DivX® video up to HD 720p, including premium content.

ABOUT DIVX VIDEO: DivX® is a digital video format created by DivX, LLC, a subsidiary of Rovi Corporation. This is an official DivX Certified® device that plays DivX video. Visit www.divx.com for more information and software tools to convert your files into DivX videos.

ABOUT DIVX VIDEO-ON-DEMAND: This DivX Certified® device must be registered in order to play purchased DivX Video-on-Demand (VOD) movies. To obtain your registration code, from the Home screen, tap Applications > Settings > About phone > Legal information > License settings > DivX® VOD > Register. Go to vod.divx.com for more information on how to complete your registration.

Contents

Assembling	9
Insert the SIM card	9
Charge the battery	10
Getting started	12
Turn your device on and off	12
Get to know your device	13
Use the touch screen	16
Get to know the Home screen	18
Access applications	21
Customize your device	21
Enter text	25
Web	31
Browser	31
Pulse	35
Market	36
YouTube	37
Maps	38
Latitude	39
Places	40
Navigation	40
Samsung Apps	41
Communication	42
Gmail	42
Email	44
Talk	47

Social Hub	48
Entertainment	49
Music	49
Music Hub	51
Camera	51
Video	58
Gallery	59
Personal information	62
Contacts	62
Calendar	65
Memo	67
Connectivity	68
PC connections	68
Wi-Fi	70
Wi-Fi Direct	71
Bluetooth	71
GPS	74
VPN connections	75
Settings	77
Access the Settings menu	77
Wireless and networks	77
Sound	79
Screen	79
Power saving mode	80
Location and security	81
Applications	82
Accounts and sync	83

Motion settings	83
Firewall	83
Privacy	84
Storage	84
Language and input	84
Accessibility	87
Date and time	88
About device	88
Tools	89
Alarm Clock	89
Calculator	90
Downloads	90
eBook	90
Google Search	92
MyFiles	92
Pen memo	94
Voice Search	94
World Clock	95
Troubleshooting	96
Safety precautions	100
Index	109

Assembling

Insert the SIM card

When you subscribe to a cellular network, you are provided with a plug-in SIM card loaded with your subscription details, such as your PIN, available optional services, and other features.

With gold contacts facing down and the angled corner of the SIM card facing into the slot, push the SIM card into the slot until it locks into place.

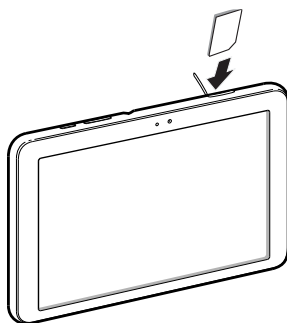



 The plug-in SIM card can be easily damaged by scratching or bending, so be careful when handling, inserting, or removing the card. Keep all SIM cards out of reach of small children.

 If the card is not inserted correctly, the tablet does not detect the SIM card. Re-orient the card back into the slot if the SIM is not detected.

Charge the battery

Your device has a built-in battery. Before using the device for the first time, you must charge the battery.

 Use only Samsung-approved chargers. Unauthorized chargers can cause batteries to explode or damage your device.

-  • Charge the battery only with a charger. You cannot charge the battery with the PC data cable.
- When your battery is low, the device will emit a warning tone and display a low battery message. The battery icon  will also be empty. If the battery level becomes too low, the device will automatically power off. Recharge your battery to continue using your device.

I Connect the PC data cable to the USB power adapter and then plug the end of the PC data cable into the multifunction jack.

 The shape of the USB power adapter may differ depending on your region.

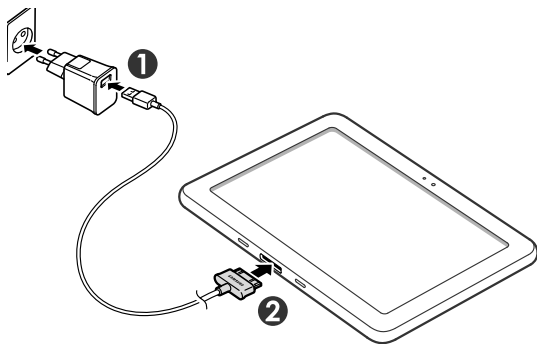

 Connecting the travel adapter improperly may cause serious damage to the device or USB power adapter. Any damage caused by misuse is not covered by the warranty.

2 Plug the USB power adapter into a power outlet.



- You can use the device while it is charging, but it may take longer to fully charge the battery.
- While the device is charging, the touch screen may not function due to an unstable power supply. If this happens, unplug the USB power adapter from the power outlet or unplug the PC data cable from the device.
- While charging, the device may heat up. This is normal and should not affect your device's lifespan or performance.
- If your device is not charging properly, bring your device and the charger to a Samsung Service Centre.

3 When the battery is fully charged (the battery icon is no longer moving), unplug the USB power adapter and PC data cable from the device and then from the power outlet.



To save energy, unplug the travel adapter when not in use. The travel adapter does not have a power switch, so you must unplug the travel adapter from the outlet to interrupt the power supply.

Getting started

Turn your device on and off

To turn on your device,

- 1 Press and hold [⏻].
- 2 If you turn on your device for the first time, follow the on-screen instructions to set up your device.

To turn off your device, press and hold [⏻] then select **Power off** → **OK**.

› Switch to Flight mode

In Flight mode, you can disable all wireless connections and use non-network services in areas where wireless devices are prohibited, such as airplanes and hospitals.

To activate Flight mode, go to **Settings** → **Wireless and networks** → **Flight mode** or press and hold [⏻] and select **Flight mode**.

To deactivate Flight mode and use wireless connections, go to **Settings** → **Wireless and networks** and clear the check box next to **Flight mode**.

Get to know your device

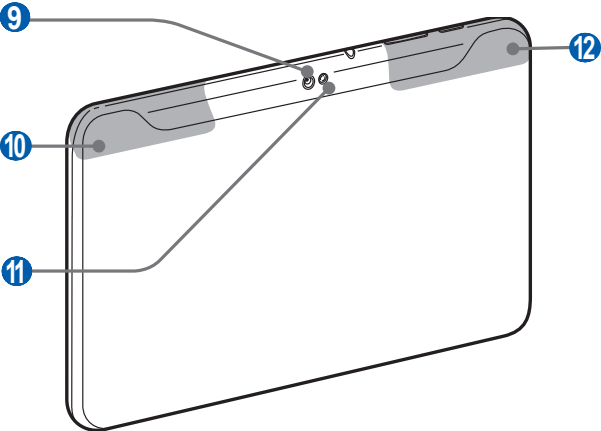
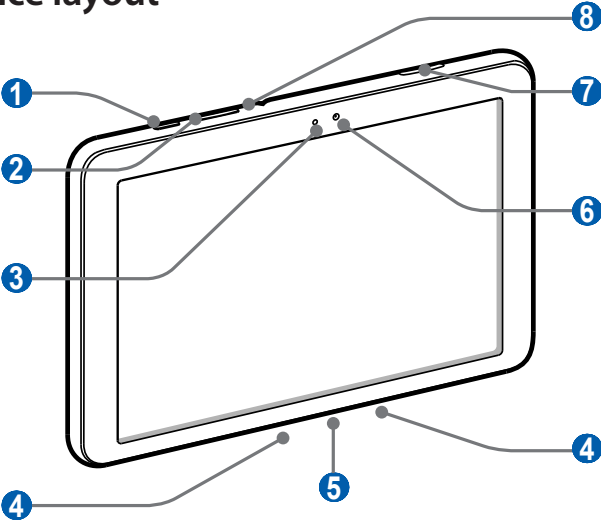

> Device layout



Number	Function
1	Power/Lock key
2	Volume key
3	Light sensor
4	Speaker
5	Multifunction jack
6	Front camera lens
7	SIM card slot
8 ¹	Headset jack
9	Rear camera lens
10	GPS antenna
11	Flashbulb
12	Internal antenna

1. Connecting a headset to your device improperly can damage the headset jack or the headset.

› Keys

Key	Function
 Power/ Reset/ Lock	Turn on the device (press and hold); reset the device* (press and hold for 8-10 seconds when starting); access the quick menus (press and hold); Lock the touch screen.
 Volume	Adjust the device's volume.

- * If your device has fatal errors or hang-ups, or freezes, you may need to reset the device to regain functionality.

› Indicator icons



Icons shown on the display may vary depending on your region or service provider.

Icon	Definition
	Signal strength (no connection if no blue bars)
	Open WLANs available
	WLAN connected
	Bluetooth activated
	Receiving GPS data
	Synchronized with the web
	Uploading data
	Downloading data
	Connected to PC
	New email message
	New Gmail
	Alarm activated
	Event notification
	Flight mode activated
	Music playback in progress
	Error occurred or caution required
¹	Battery power level
	Unable to charge
10:00	Current time

1. If you use a charger that is not approved by Samsung, this indicator will not appear.

Use the touch screen

Your device's touch screen lets you easily select items or perform functions. Learn basic actions to use the touch screen.



- To avoid scratching the touch screen, do not use sharp tools.
- Do not allow the touch screen to come into contact with other electrical devices. Electrostatic discharges can cause the touch screen to malfunction.
- Do not allow the touch screen to come into contact with water. The touch screen may malfunction in humid conditions or when exposed to water.



- For optimal use of the touch screen, remove the screen protection film before using your device.
- Your touch screen has a layer that detects small electrical charges emitted by the human body. For best performance, tap the touch screen with your fingertip. The touch screen will not react to touches of sharp tools, such as a stylus or pen.

You can control your touch screen with the following actions:

- Tap: Touch once with your finger to select or launch a menu, option, or application.
- Drag: Tap and drag your finger up, down, left, or right to move to items on lists.
- Tap and hold: Tap an item and hold it for more than 2 seconds to open a pop-up option list.
- Drag and drop: Tap and hold your finger on an item, and then drag your finger to move the item.
- Double-tap: Tap twice quickly with your finger to zoom in or out while viewing photos.

› Rotate the touch screen

Your device has a built-in sensor that detects its orientation. If you rotate the device, the interface will automatically rotate according to the orientation.

To set the interface to keep the orientation, select the system bar at the bottom right of the screen and then select **Auto rotation** on the notifications panel.

› Lock or unlock the touch screen

When you do not use the device for a specified period, your device turns off the touch screen and automatically locks the touch screen to prevent any unwanted device operations. To manually lock the touch screen, press [⏻].

To unlock, turn on the screen by pressing [⏻], and drag [🔒] in any direction until it reaches the border of the circle. If you set a screen lock, you need to enter your PIN or password, or draw a pattern. ▶ 24

Get to know the Home screen

When the device is in Idle mode, you will see the Home screen. From the Home screen, you can view your device's status and access applications. Scroll left or right to a panel of the Home screen.

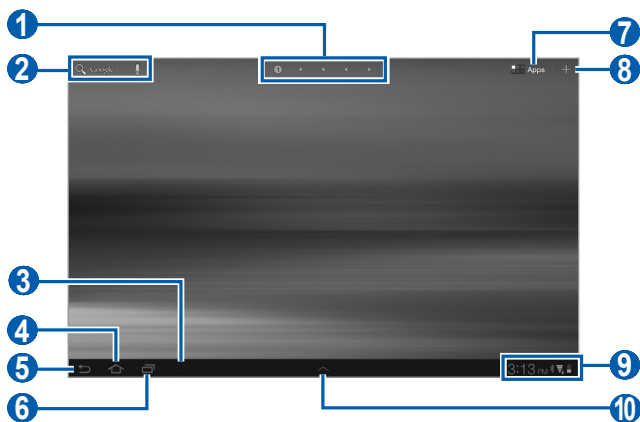

The above screen may differ depending on your region or service provider.

Number	Function
1	Select a dot at the top of the screen to move to the corresponding panel directly.
2	Search the web with the Google Search widget.
3	Capture the current screen.
4	Return to the Home screen.
5	Return to the previous screen.
6	Open the list of recent applications.
7	Access the application list.
8	Customize the Home screen.

Number	Function
9	Display indicator icons and your device's current status; Open the notifications panel.
10	Open the shortcuts panel.

› Add items to the Home screen

You can customize the Home screen by adding shortcuts to applications or items in applications, widgets, or folders.

To add an item to the Home screen,

- 1 From the Home screen, select **+**.
- 2 Select an item category.
 - **Widgets:** Add widgets. Widgets are small applications that provide convenient functions and information on your Home screen.
 - **App shortcuts:** Add shortcuts to applications on the Home screen.
 - **Wallpapers:** Set a background image.
 - **More:** Add shortcuts to items, such as bookmarks, contacts, and maps.
- 3 Select an item to add to the Home screen.

› Move items on the Home screen

- 1 Tap and hold an item to move until the Home screen grid appears.
- 2 Drag the item to the location you want.

› Remove items from the Home screen

- 1 Tap and hold an item to remove.
The trash bin appears at the top right of the Home screen.
- 2 Drag the item to the trash bin.
- 3 When the item turns red, release the item.

› Add a shortcut to an application

- 1 From the application list, tap and hold an application icon and drag it to a Home screen panel at the bottom of the screen.
The shortcut icon for the application is added to the Home screen.
- 2 Move the icon to the location you want or move it to another panel of the Home screen.

› Use the notifications panel

From the Home screen or while using an application, select the right side of the system bar, and then select an option on the notifications panel.

You can view the device's current status and use the following options:

- **Wi-Fi:** Activate or deactivate the WLAN feature.
- **Notifications:** Set the device to alert you for various events.
- **GPS:** Activate or deactivate the GPS feature.
- **Sound/Vibration:** Activate or deactivate Silent mode.
- **Auto rotation:** Activate or deactivate the auto rotation.
- **Bluetooth:** Activate or deactivate the Bluetooth wireless connection feature.
- **Flight mode:** Activate or deactivate Flight mode.

Drag the panel left or right to view options not visible on the screen.

You can also adjust the display brightness or access the settings menu.



Available options may vary depending on your region or service provider.

Access applications

- 1 From the Home screen, select **Apps** to access the application list.
- 2 Select **All** → an application.
To view downloaded applications, select **My apps**.
- 3 Select ↶ to return to the previous screen; Select 🏠 to return to the Home screen.

› Access recent applications

- 1 Select 📄 to open the list of applications you have accessed recently.
- 2 Select an application.

Customize your device

Get more from your device by customizing it to match your preferences.

› Change the language of the display

- 1 From the Home screen, open the application list and select **Settings** → **Language and input** → **Select language**.
- 2 Select the language you want.

› Set the current time and date

- 1 From the Home screen, open the application list and select **Settings** → **Date and time**.
- 2 Select **Automatic date and time** or set your time zone and the time and date. You can also change the time and date formats.

› Turn the touch tone on or off

From the Home screen, open the application list and select **Settings** → **Sound** → **Audible selection**.

› Adjust the device's volume

- 1 Press the Volume key up or down.
- 2 Select  and drag the sliders to adjust the volume level for media sounds and notifications.

› Switch to Silent mode

From the Home screen or while using an application, select the right side of the system bar and then select **Sound** on the notifications panel.

You can also press and hold [] and select **Silent mode** to mute or unmute your device.



You can set the device to vibrate to alert you to various events in Silent mode. From the Home screen, open the application list and select **Settings** → **Sound** → **Vibrate** → **Always, Never, Only in Silent mode** or **Only when not in Silent mode**. When you switch to Silent mode, **Vibration** will appear in place of **Silent** on the notifications panel.

› Select a wallpaper for the Home screen

- 1 From the Home screen, select **+** → **Wallpapers**.
- 2 Select an image folder.
- 3 If you selected the Wallpapers folder, select **Home screen Wallpaper** and select an image.
If you selected Live Wallpapers, select a wallpaper and select **Set wallpaper**.
If you selected Gallery, select **Home screen Wallpaper**, select an image, move or resize the rectangle to select a portion of the image, and then select **Ok**.



Samsung is not responsible for any use of default images or wallpapers provided on your device.

› Activate animation for switching windows

You can set a transition effect between windows while using the device.

- 1 From the Home screen, open the application list and select **Settings** → **Screen** → **Animation**.
- 2 Select an animation option.

› Adjust the brightness of the display

- 1 From the Home screen, open the application list and select **Settings** → **Screen** → **Brightness**.
- 2 Clear the check box next to **Automatic brightness**.
- 3 Drag the slider to adjust the level of brightness.
- 4 Select **OK**.



The brightness level of the display will affect how quickly the device consumes battery power.

› Set a screen lock

You can lock the touch screen with an unlock pattern or password to prevent unauthorized people from using the device without your permission.



- Once you set a screen lock, your device will require an unlock code each time you turn it on or unlock the touch screen.
- If you forget your PIN or password, bring your device to a Samsung Service Centre to reset it.
- Samsung is not responsible for any loss of security codes or private information or other damages caused by illegal software.

Set an unlock pattern

- 1 From the Home screen, open the application list and select **Settings** → **Location and security** → **Configure lock screen** → **Pattern**.
- 2 See the on-screen instructions and example patterns and select **Next**.
- 3 Draw a pattern by dragging your finger to connect at least 4 dots.
- 4 Select **Continue**.
- 5 Draw the pattern again to confirm.
- 6 Select **Confirm**.

Set an unlock PIN code

- 1 From the Home screen, open the application list and select **Settings** → **Location and security** → **Configure lock screen** → **PIN**.
- 2 Enter a new PIN (numeric) and select **Continue**.
- 3 Enter the PIN again and select **OK**.

Set an unlock password

- 1 From the Home screen, open the application list and select **Settings** → **Location and security** → **Configure lock screen** → **Password**.
- 2 Enter a new password (alphanumeric) and select **Continue**.
- 3 Enter the password again and select **OK**.

Enter text

You can enter text by selecting characters on the virtual keypad, inputting handwriting on the screen, or speaking words into the microphone.

-  You cannot enter text in some languages. To enter text, you should change the writing language to one of the supported languages. ► p. 84

► Change the keyboard type

You can change the keyboard type.

- 1 From the Home screen, open the application list and select **Settings** → **Language and input** → **Current input method**.
- 2 Select a keyboard type (Android keyboard, Samsung keypad, or Swype).

You can also enter text with your voice. Select a voice input option, according to the language you want to use.

› Enter text using the Android keyboard

Enter text by selecting alphanumeric keys and you can use the following keys:



Number	Function
1	Move the cursor to the next text input field.
2	Switch between Number/Symbol mode and ABC mode.
3	Change case.
4	Access the keypad settings; Change the keypad type or activate the voice input feature (tap and hold).
5	Insert an emoticon; Open the emoticon list (tap and hold).
6	Clear your input.
7	Start a new line.
8	Enter text by voice.
9	Insert a space.

› Enter text using the Samsung keypad

Enter text by selecting alphanumeric keys and you can use the following keys:

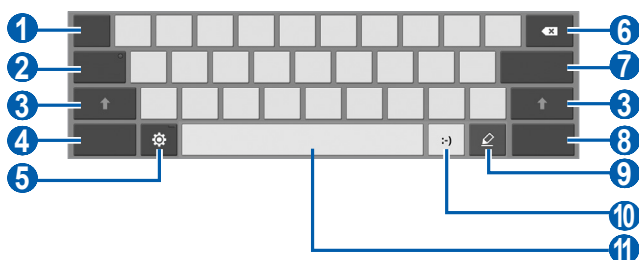

Number	Function
1	Change the keypad size.
2	Move the cursor to the next text input field.
3	Change case.
4	Switch between Number/Symbol mode and ABC mode.
5	Access the keypad settings; Change the keypad type or activate the voice input feature (tap and hold).
6	Clear your input.
7	Start a new line.
8	Attach an item.
9	Insert an emoticon; Open the emoticon list (tap and hold).
10	Enables handwriting recognition
11	Insert a space.

› Enter text using the Swype keypad

- 1 Select the first character of a word and drag your finger to the second character without releasing the finger from the screen.
- 2 Continue until you have finished the word.

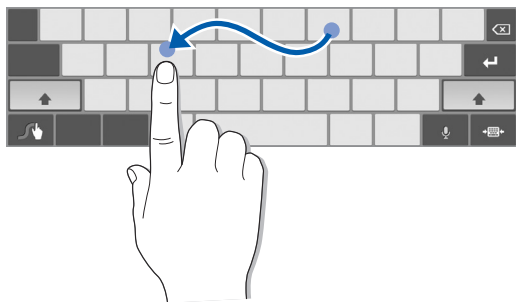



- 3 Release the finger on the last character.
- 4 When the word displays correctly, select  to insert a space. If the correct word does not display, select an alternative word from the list that appears.
- 5 Repeat steps 1-4 to complete your text.



- You can also tap the keys to enter text.
- You can tap and hold a key to enter characters on the upper half of the key. When you tap and hold a key until the character list appears, you can enter special characters and symbols.

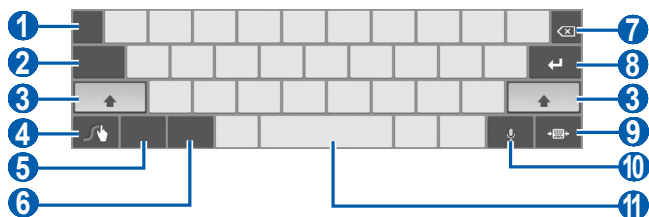

You can also use the following keys:



Number	Function
1	Change the input language.
2	Move the cursor to the next text input field.
3	Change case.
4	Access the swype tip screen; Open the help information (tap and hold).
5	Switch between Symbol mode and ABC mode.
6	Switch between Number mode and Edit mode.
7	Clear your input.
8	Start a new line.
9	Minimize the virtual keypad.
10	Enter text by voice.  This feature may be unavailable depending on the selected input language.
11	Insert a space.

› Copy and paste text

While you are entering text, you can use the copy and paste feature to use text in other applications.

- 1 Tap and hold a word.
- 2 Drag  or  to select the text you want.
- 3 Select **Copy** to copy, or **Cut** to cut the text onto the clipboard.
- 4 In another application, tap and hold the text input field.
- 5 Select **Paste** to insert the text from the clipboard into the text input field.

Web

Browser

Learn to access and bookmark your favourite web pages.



- The web browser menu may be labeled differently depending on your service provider.
- Available icons may vary depending on your region or service provider.

> Browse web pages

1 From the Home screen, open the application list and select **Browser** to launch your homepage.

To access a specific web page, select the URL input field, enter the web address of the web page, and select .



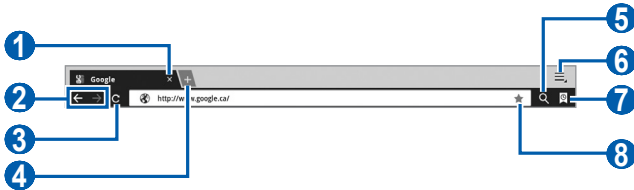





2 Navigate web pages with the following keys:



Number	Function
1	Close the current tab.
2	Move backward or forward to web pages in history.
3	Reload the current web page; While the device is loading web pages, this icon changes to  .



Number	Function
4	Open a new tab.
5	Search for information.
6	Access a list of web browser options.
7	Open a list of saved bookmarks and recent internet history.
8	Bookmark the current web page.

While browsing the web page, use the following options:

- To zoom in or out, tap the screen with two fingers and spread them apart (move your fingers closer together to zoom out).
- To open a new tab, select  → **New tab**.
- To open a new tab without saving cookies, select  → **New incognito tab**.
- To search for text on the web page, select  → **Find on page**.
- To send the web address of the web page to others, select  → **Share page**.
- To save a page image, select  → **Save page**.
- To view page details, select  → **Page info**.
- To view the items downloaded from the web, select  → **Downloads**.
- To print the web page, select  → **Print**.
- To customize browser settings, select  → **Settings**.

› Search for information by voice

 This feature may be unavailable depending on your region or service provider.

- 1 From the Home screen, open the application list and select **Browser**.
- 2 Select .
- 3 Select  and say a keyword into your device's microphone.
The device searches for information and web pages related with the keyword.

› Open multiple pages



You can open multiple pages and switch back and forth between them.

- 1 From the Home screen, open the application list and select **Browser**.
- 2 Select  to open a new tab.
- 3 Access another web page on the new tab.
- 4 To switch back and forth between currently open tabs, select the title of a tab.

› Bookmark your favourite web pages

If you know the web address of the web page, you can manually add a bookmark.

Add a bookmark



- 1 From the Home screen, open the application list and select **Browser**.
 - 2 Select  → .
- You can also select  to bookmark the current web page.

- 3 Enter a page title and a web address.
To bookmark the web page you were viewing, skip to step 5.
- 4 Select the **Bookmarks** drop-down menu and select a bookmark location to add (if necessary).
- 5 Select **OK**.

To use bookmark options, select , tap and hold a bookmark:

- To open the web page in the current tab, select **Open**.
- To open the web page in a new tab, select **Open in new tab**.
- To edit the bookmark, select **Edit bookmark**.
- To add the bookmark shortcut to the Home screen, select **Add shortcut to home**.
- To send the web address of the web page to others, select **Share link**.
- To copy the web address of the web page, select **Copy link URL**.
- To delete the bookmark, select **Delete bookmark**.
- To use the web page as your homepage of the browser, select **Set as homepage**.

Create a bookmark folder

- 1 From the Home screen, open the application list and select **Browser**.
- 2 Select  →  → **New folder**.
- 3 Enter a name for the bookmark folder and select **Done**.





› Access recent history

- 1 From the Home screen, open the application list and select **Browser**.
- 2 Select  → **History**.
- 3 Select a web page to access.



Pulse

You can use the Pulse reader to add feeds for your favourite news topics and read news articles on your device.

› Read feeds

- 1 From the Home screen, open the application list and select **Pulse**.
- 2 If you are launching this application for the first time, select **OK** and tap the screen to clear the hint.
- 3 Select  to update feeds.
- 4 Scroll up or down to select a feed source.
- 5 Scroll left or right and select a feed.
- 6 While reading a feed, use the following options:
 - To upload a feed to community websites, select  or .
 - To send a feed to others, select .
 - To return to a feed list, select .

› Manage feed sources

- 1 From the Home screen, open the application list and select **Pulse**.
- 2 Select  to view the feed source list.
- 3 Select  or  to add or delete a feed.

› Customize the reader settings

- 1 From the Home screen, open the application list and select **Pulse**.
- 2 Select  → **Settings** to customize the display or sync settings for the Pulse reader.

Market

Based on the Android platform, your device's functionality can be extended by installing additional applications. Android Market provides you an easy and quick way to shop for games and mobile applications.



- This feature may be unavailable depending on your region or service provider.
- Your device will save user files from downloaded applications to the internal memory.

› Download and install an application

- 1 From the Home screen, open the application list and select **Market** from the list or at the top right of the screen.
- 2 If you are launching this application for the first time, read the terms and conditions and select **Accept**.
- 3 Search for a file or application and download it.

› Uninstall an application

- 1 From the Home screen, open the application list and select **Market**.
- 2 Select **My apps**.
- 3 Select the item you want to delete.
- 4 Select **Uninstall**.

YouTube

Learn to view and upload videos via YouTube.



This feature may be unavailable depending on your region or service provider.

› Watch videos

- 1 From the Home screen, open the application list and select **YouTube**.
- 2 Select a video from the list.
- 3 Select a video screen →  to display a full screen.
- 4 Control playback with the virtual keys.







› Upload videos

- 1 From the Home screen, open the application list and select **YouTube**.
- 2 Select **Your Channel**.
- 3 Select your Google account if it is linked to YouTube. You can also select **Add account** and set up an account to sign in YouTube.
- 4 Select **Upload** and then select a video.
- 5 Enter details for the upload and select **Upload**.

Maps



Learn to use Google Maps™ to find your location, search the map for streets, cities, or countries, and get directions.

› Search for a specific location

- 1 From the Home screen, open the application list and select **Maps**.
- 2 If you are launching this application for the first time, select **OK**.
- 3 Select **Settings** to activate location services. ► p. 81
The map will display your current location.
- 4 Select **Search Maps**.
- 5 Enter a keyword for the location and select 
 - To search for a location by voice, select .
 - To view your current location, select .
 - To search for a place around you, select .
 - To get directions to a specific destination, select .
 - To add layers to the map, select .
 - To access a list of other options, select .
 - To zoom in or out, place two fingers on the screen and spread them apart (move your fingers closer together to zoom out) or double-tap the screen.

› Get directions to a specific destination

- 1 From the Home screen, open the application list and select **Maps**.
- 2 Select .

- 3 Enter the addresses of the starting location and the ending location.
To enter an address from your contact list or point the location on the map, select  → **Contacts, Point on map,** or **My Places**.
- 4 Select a travel method (car, bus, bicycle or walk) and select **Go**.
- 5 Select a travel route to view details of your trip (if necessary).
- 6 When you are finished, select  → **Clear Map**.

Latitude

Learn to share your location with your friends and view friends' locations via Google Latitude™.

 This feature may be unavailable depending on your region or service provider.



- 1 From the Home screen, open the application list and select **Latitude**.
The device automatically joins Latitude.
- 2 Select  → **Select from Contacts** or **Add via email address**.
- 3 Select a friend you want to add, or enter an email address and select **Add friends**.
- 4 Select **Yes**.
When your friend accepts your invitation, you can share locations.
- 5 Select a friend from the list.
Your friends' locations are marked with their photos on the map.

Places

Learn to search for a place around you.



This feature may be unavailable depending on your region or service provider.

- 1 From the Home screen, open the application list and select **Places**.
- 2 Select a category.
Your device searches for places around your current location that are related to the category.
- 3 Select a place name to view its details.
- 4 To view the place on the map, select .
To view the route to the place, select .

Navigation

Learn to use the GPS navigation system to find and show your destination with voice guidance.



This feature may be unavailable depending on your region or service provider.

- 1 From the Home screen, open the application list and select **Navigation**.
- 2 If you are launching this application for the first time, select **Accept**.
- 3 Enter your destination by using one of the following methods:
 - **Speak Destination:** Speak your destination such as "Navigate to destination."
 - **Type Destination:** Enter your destination with the virtual keypad.

- **Contacts:** Select your destination from addresses of your contacts.
- **Starred Places:** Select your destination from the list of your starred places.

4 Follow the on-screen instructions to use the navigation service.

Samsung Apps

Samsung Apps allows you to simply and easily download an abundance of applications directly to your device. Featuring a wealth of games, news, reference, social networking, navigation, health related applications and more, Samsung Apps gives you instant access to a huge choice of mobile experience.

Your device gets smarter with fully optimized applications from Samsung Apps. Explore amazing applications and make your mobile life even better.



- This feature may be unavailable depending on your region or service provider.
- For details, please visit www.samsungapps.com.

- 1 From the Home screen, open the application list and select **Samsung Apps**.
- 2 If you are launching this application for the first time, select your region → **OK**. Then read the terms and conditions and select **Accept**.
- 3 Search for and download applications as desired.

Communication



Gmail

You can retrieve new email messages from Gmail™ to your Inbox. When you access this application, the Inbox screen appears. The total number of unread messages displays in the title bar and unread messages display in bold.



- This feature may be unavailable depending on your region or service provider.
- The Gmail menu may be labeled differently depending on your service provider.

› Send an email message

- 1 From the Home screen, open the application list and select **Gmail**.
- 2 Select .
- 3 Enter a name or address in the To: field.
- 4 Enter a subject and message.
- 5 Select  → a file to attach an image file.
- 6 Select **Send** to send the message.

› View an email message

- 1 From the Home screen, open the application list and select **Gmail**.
- 2 Select an email message.

From the message view, use the following options:

- To move to the previous or next message, select **Older** or **Newer**.
- To search for an email message, select .
- To create a new message, select .
- To customize the settings for viewing the message, select .
- To delete the message, select .
- To make the message as unread, select  → **Mark unread**.
- To mark a message as important or not important, select  → **Mark important/not important**.
- To add a label to a message, select  → **Change labels**.
- To register the message to the spam list, select  → **Report spam**.
- To hide the message, select  → **Mute**.
- To move a message to a different folder, drag the message and drop it on the other folder.
- To reload the messages, select  → **Refresh**.
- To customize the email settings, select  → **Settings**.
- To view Gmail help, select  → **Help**.
- To complete the Gmail feedback form, select  → **Feedback?**
- To reply to the message, select .
- To reply to the message including all recipients, select .
- To forward the message to other people, select .
- To add a star to the message, select .
- To view an attachment, select **View** or **Play**. To save it to your device, select **Save**.

Email





Learn to send or view email messages via your personal or company email account.

› Set up an email account

- 1 From the Home screen, open the application list and select **Email**.
- 2 Enter your email address and password.
- 3 Select **Next** (for general email accounts) or **Manual setup** (for other company email accounts).
- 4 Follow the on-screen instructions.
- 5 To add more email accounts, select  → **Settings** → **Add account** and repeat steps 2-4.

When you are finished setting up the email account, the email messages are downloaded to your device. If you have created more than two accounts, you can switch between email accounts; Select an account name at the top left of the screen and select the one you want to retrieve messages from.

› Send an email message















- 1 From the Home screen, open the application list and select **Email** → an email account (if necessary).
 - 2 Select .
 - 3 Add recipients of your message.
Enter email addresses manually, separating them with a semicolon or a comma, or select  to choose from your contact list.
 - 4 Select **+ Cc/Bcc** and add more recipients.
 - 5 Select the subject field and enter a subject.
 - 6 Select the text input field and enter your email text.
 - 7 Select  to attach files.
You can select a file from the file list or create a new drawing, photo, video, or sound.
 - 8 Select  to insert files into the body of the message.
You can select a file from the file list or create a new drawing.
 - 9 Select **Send** to send the message.
-  If you are offline or outside your service area, the message will be held in the outbox until you are online and in your service area.

› View an email message

When you open an email account, you can view previously retrieved emails offline or connect to the email server to view new messages. After retrieving email messages, you can view them offline.

- 1 From the Home screen, open the application list and select **Email** → an email account (if necessary).
- 2 Select  to update the message list.
- 3 Select an email message.

From the message view, use the following options:

- To search for an email message, select .
- To reload the messages, select .
- To create a new message, select .
- To reply to the message, select .
- To forward the message to other people, select .
- To delete the message, select .
- To mark the message as unread, select  → **Mark as unread**.
- To move the message to another folder, select  → **Move**.
- To view the messages by category, select  → **List by**.
- To change the view mode, select  → **View mode**.
- To change the background colour, select  → **Background color**.
- To print the message, select  → **Print**.
- To customize the settings for the account, select  → **Settings**.
- To add a star to the message, select .
- To save an attachment to your device, select the attachment tab → .

Talk

Learn to chat with friends and family via Google Talk™.



This feature may be unavailable depending on your region or service provider.

› Set your status

- 1 From the Home screen, open the application list and select **Talk**.
- 2 Enter your Google account and password and select **Sign in** (if necessary).
- 3 Customize your status, image, and message to display.

› Add friends to your friend list

- 1 From the Home screen, open the application list and select **Talk**.
The friend list shows all of your Google Talk contacts at a glance.
- 2 Select .
- 3 Enter an email address of the friend and select **Send invitation**.

When your friend accepts the invitation, the friend is added to your friend list.

› Start a chat

- 1 From the Home screen, open the application list and select **Talk**.
- 2 Select a friend from the friend list. The chat screen opens.
- 3 Enter your message and select ►.
To add a friend to a chat, select ▲ → **Add to chat**.
- 4 To end the chat, select ✕.

Social Hub

Learn to access Social Hub™, the integrated communication application for email, messages, instant messages, contacts or calendar information. Visit socialhub.samsungapps.com for more details.

- 1 From the Home screen, open the application list and select **Social Hub**.
- 2 Select a category at the left of the screen.
- 3 Check and use contents delivered from Social Hub.

Entertainment

Music

Learn to listen to your favourite music while on the go with the music player.



- Some file formats are not supported depending on the software of the device.
- If the file size exceeds the available memory, an error can occur when you open files.

› Add music files to your device

Start by transferring files to your device:



- Download from the wireless web. ▶ p. 31
- Download from a PC with Samsung Kies. ▶ p. 68
- Receive via Bluetooth. ▶ p. 73
- Synchronize with Windows Media Player. ▶ p. 68



› Play music

After transferring music files to your device,



- 1 From the Home screen, open the application list and select **Music player**
- 2 Select a music category → a music file.
- 3 Tap the music player field at the right of the screen.
- 4 Control playback with the virtual keys.

While playing music, use the following options:

- To add a music file to a playlist, select  → **Add to playlist.**
- To listen to music via a Bluetooth headset, select  → **Via Bluetooth.**
- To send a music file to others, select  → **Share via.**

- To set a music file as an alarm tone, select  → **Set as alarm tone**.
 - To customize your music player, select  → **Settings**.
-  • 5.1 Ch produces a surround sound experience over the built-in speakers and standard headphones or earbuds.
- WOW HD™ significantly improves the playback quality of audio, delivering a dynamic 3D entertainment experience with deep, rich bass and high frequency clarity for crisp detail.

› Create a playlist

- 1 From the Home screen, open the application list and select **Music player**.
- 2 Select  → **New playlist**.
- 3 Enter a title for your new playlist and select **Done**.
- 4 To add music files to the playlist, select  next to the music files you want to add and select **Done**.

› Customize music player settings

- 1 From the Home screen, open the application list and select **Music player**.
- 2 Select  → **Settings**.
- 3 Adjust the following settings to customize your music player:

Option	Function
Equaliser	Select a default sound equalization setting.
Sound effects	Select a sound effect.
Music auto off	Music turns off after preset time.

Option	Function
Music menu	Select music categories to display on the music library screen.

Music Hub

You can access the online music store, and search for and buy your favourite songs. You can also add a music file to your wish list and play downloaded music files.



This feature may be unavailable depending on your region or service provider.

- 1 From the Home screen, open the application list and select **Music Hub**.
- 2 If you are launching this application for the first time, select **Confirm**.
- 3 Search for songs, and preview or buy your favourite songs.

Camera

Learn how to capture and view photos and videos. You can take photos at resolutions up to 2048 x 1536 pixels (3.2 megapixels) and videos at resolutions up to 1280 x 720 pixels.



- The camera automatically turns off when you do not use it for a specified period.
- The memory capacity may differ depending on the shooting scene or shooting conditions.

› Capture a photo

- 1 From the Home screen, open the application list and select **Camera** to turn on the camera.
- 2 Aim the lens at the subject and make any necessary adjustments.

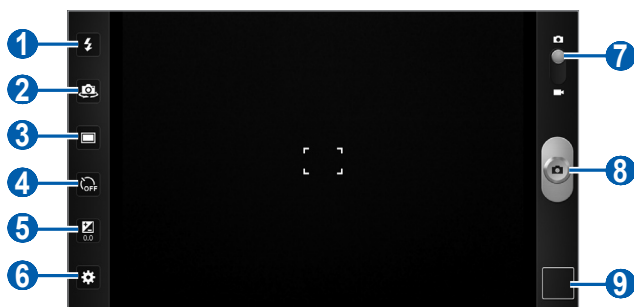

Number	Function
1	Change the flash setting. You can manually turn the flash on or off, or set the camera to automatically use the flash when needed.
2	Switch between the front and rear camera lenses.
3	Change the shooting mode.
4	Select the length of the delay before the camera takes a photo.
5	Adjust the exposure value.
6	Change the camera settings.
7	Switch to the camcorder.
8	Capture a photo.
9	Open the image viewer to view photos you captured.



- 3 Tap where you want to focus on the preview screen. The focus frame moves to the place you tap and changes to green when the subject is in focus.
- 4 Select  to take a photo. The photo is saved automatically.

After taking photos, select the image viewer icon to view the captured photos.

- To view more photos, scroll left or right. You can also tap the screen and scroll through the thumbnails of photos at the bottom of the screen.
- To zoom in or out, place two fingers on the screen and spread them apart (move your fingers closer together to zoom out) or double-tap the screen.
- To send a photo to others, select **Share via**.
- To set a photo as wallpaper or a caller image for a contact, select **Set as**.
- To delete a photo, select **Delete**.
- To open the Gallery, select **Go to Gallery**.



➤ Capture a photo by using preset options for various scenes

Your camera provides you with predefined settings for various scenes. You can simply select the proper mode for your shooting condition and subjects. For example, when you take photos at night, select the night mode that uses an extended exposure.

- 1 From the Home screen, open the application list and select **Camera** to turn on the camera.
- 2 Select  → **Scene mode** → a mode.
- 3 Make any necessary adjustments.
- 4 Select  to take a photo.



› Capture a photo in Self shot mode

You can take photos of yourself conveniently using the front camera lens.

- 1 From the Home screen, open the application list and select **Camera** to turn on the camera.
- 2 Select .
- 3 Make any necessary adjustments.
- 4 Select  to take a photo.



› Capture a photo in Smile shot mode

Your camera can recognize people's faces and help you take photos of their smiling faces.

- 1 From the Home screen, open the application list and select **Camera** to turn on the camera.
- 2 Select  → **Smile shot**.
- 3 Make any necessary adjustments.
- 4 Select .
- 5 Aim the camera lens at your subject.
Your device recognizes people in an image and detects their smiles. When the subject smiles, the device automatically takes a photo.

› Capture a panoramic photo



You can take wide panoramic photos using Panorama shooting mode. This mode is convenient for photographing landscapes.

- 1 From the Home screen, open the application list and select **Camera** to turn on the camera.
- 2 Select  → **Panorama**.
- 3 Make any necessary adjustments.
- 4 Select  to take the first photo.

- 5 Slowly move the device in any direction and align the green frame with the viewfinder.
When you have aligned the green frame and viewfinder, the camera will automatically take the next photo.
- 6 Repeat step 5 up to seven times to complete the panoramic photo. To stop the photo capture before you have taken eight photos, select .

▶ Capture a photo of action

You can capture shots of a moving subject and then combine them into a single photo that shows the action.

- 1 From the Home screen, open the application list and select **Camera** to turn on the camera.
- 2 Select  → **Action shot**.
- 3 Make any necessary adjustments.
- 4 Select  to take the first photo.
- 5 Move the device to follow the moving subject.
The device automatically takes the next photos.
- 6 Continue to follow the subject until the device has captured all the shots necessary for the action photo.

› Customize camera settings

Before taking a photo, select  to access the following options:



Option	Function
Focus mode	Select Macro to take close-up photos or Auto focus to have the camera automatically focus on the subject.
Scene mode	Change the scene mode.
White balance	Adjust the colour balance according to lighting conditions.
Effects	Apply a special effect (Grayscale, Sepia or Negative).
Resolution	Set the image resolution.
Metering	Select the image area used by the exposure meter to calculate the exposure.
GPS tag	Set the camera to include location information for your photos. To use this feature, you must activate location services. ► p. 81

› Record a video

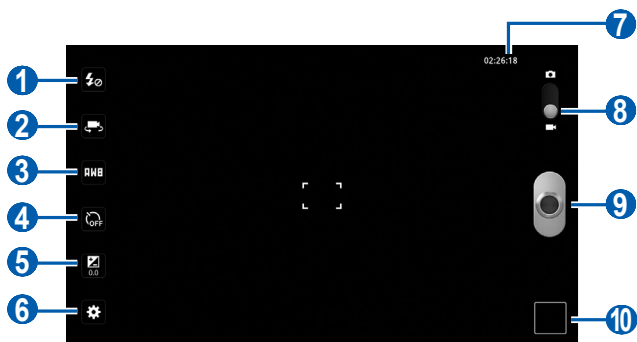
- 1 From the Home screen, open the application list and select **Camera** to turn on the camera.
- 2 Drag the slider at the top right of the screen to switch to the camcorder.
- 3 Aim the lens at the subject and make any necessary adjustments.



Number	Function
1	Change the flash setting; You can manually turn the flash on or off.
2	Switch between the front and rear camera lenses.
3	White balance: Adjust the colour balance according to lighting conditions.
4	Select the length of the delay before the camera starts recording a video.
5	Adjust the exposure value.
6	Change the camcorder settings.
7	View the length of video that can be recorded (according to available memory).
8	Switch to the camera.
9	Record a video.
10	Open the image viewer to view videos you recorded.

- 4 Select  to start recording.
- 5 Select  to stop recording.
The video is saved automatically.

After recording videos, select the image viewer icon to view the recorded videos.

- To view more videos, scroll left or right. You can also tap the screen and scroll through the thumbnails of videos at the bottom of the screen.
- To play a video, select .
- To send a photo to others, select **Share via**.
- To delete a photo, select **Delete**.
- To open the Gallery, select **Go to Gallery**.

› Customize camcorder settings

Before recording a video, select  to access the following options:

Option	Function
Effects	Apply a special effect (Grayscale, sepia or Negative).
Resolution	Change camcorder resolution.





Video

Learn to use the video player to play various kinds of videos.

- 1 From the Home screen, open the application list and select **Video player**.
- 2 Select a view mode at the top of the screen.

- 3 Select a video to play.
- 4 Control playback with the virtual keys.

While playing a video, use the following options:

- To send a video to others, select  → **Share via**.
- To apply a colour effect, select  → **Colour tone**.
- To activate outdoor visibility to select an appropriate lighting condition, select  → **Outdoor visibility**.
- To view video details, select  → **Details**.

Gallery

Learn to view photos and play videos saved in your device's memory.

› Supported file formats

Type	Format
Image	.bmp, .gif, .ico, .jpg, .svg (SVGT)
Video	.mp4, .3gp, .avi, .flv, .wmv, .asf, .mkv, DivX
Audio	.mp3, .ogg, .aac, .wma, .mp4, .m4a





- Some file formats are not supported depending on the software of the device.
- If the file size exceeds the available memory, an error can occur when you open files.

› View a photo

1 From the Home screen, open the application list and select **Gallery**.

2 Select a folder.











 To filter photos and videos, select **By album** or  → **Images and videos** → an option.

3 Select a photo (with no  icon) to view.



While viewing a photo, use the following options:

- To view more photos, scroll left or right.
- To zoom out or in, tap the screen with two fingers and spread them apart (move your fingers closer together to zoom out).

 If you activated tilting motions, you can zoom in or out by tapping and holding two points with your fingers and then tilting the device back and forth.

- To start a slideshow in the selected folder, select . Tap the screen to stop the slideshow.
- To send a photo to others, select .
- To delete a photo, select .
- To view photo details, select  → **Details**.
- To rotate a photo counter-clockwise, select  → **Rotate Left**.
- To rotate a photo clockwise, select  → **Rotate Right**.
- To set a photo as wallpaper or a caller image for a contact, select  → **Set picture as**.
- To crop an image from a photo, select  → **Crop**.
- To print a photo using a USB connection or a WLAN connection, select  → **Print**. Your device is compatible only with select Samsung printers.
- To copy a photo, select  → **Copy**.
- To change motion activation settings, select  → **Motion**.

› Play a video

- 1 From the Home screen, open the application list and select **Gallery**.
- 2 Select a folder.
 To filter photos and videos, select **By album** or  → **Images and videos** → an option.
- 3 Select a video (with the  icon) to play.
- 4 Control playback with the virtual keys.

Personal information

Contacts

Learn to create and manage a list of your personal or business contacts. You can save names, mobile phone numbers, home phone numbers, email addresses, birthdays and more for your contacts.

› Create a contact

- 1 From the Home screen, open the application list and select **Contacts**.
- 2 Select **+**.
- 3 Enter contact information.
- 4 Select **Done** to add the contact to memory.

› Retrieve contacts from your account



You can retrieve contacts by synchronizing your assigned account.

- 1 From the Home screen, open the application list and select **Settings** → **Accounts and sync**.
- 2 Select an account →  to synchronize your contact list. An updated contact list is retrieved and saved on your device automatically.

› Find a contact

- 1 From the Home screen, open the application list and select **Contacts**.
- 2 Select **Search contacts** and enter the first few letters of a name.
- 3 Select the contact's name.

Once you find a contact, you can use the following options:

- To send an email message, select an email address.
- To edit the contact information, select .
- To set as a favourite, select .

› Import or export contacts

To import contact files (in vcf format) from your device's USB storage,

- 1 From the Home screen, open the application list and select **Contacts**.
- 2 Select  → **Import/Export** → **Import from USB storage**.
- 3 Select a memory location.
If you have more than one account, select an account to which you want to add the contact.
- 4 Select an option for importing a single contact file, multiple contact files, or all contact files, and select **OK**.
- 5 Select contact files to import and select **OK**.

To export contacts to your device's USB storage,

- 1 From the Home screen, open the application list and select **Contacts**.
- 2 Select  → **Import/Export** → **Export to USB storage**.
- 3 Select **OK** to confirm.

› Create your namecard

- 1 From the Home screen, open the application list and select **Contacts**.
- 2 Select  → **My profile** → **Edit**.
- 3 Enter your own personal details.
- 4 Select **Done**.



You can send your namecard by attaching it to an email or transferring it via the Bluetooth wireless feature.

› Retrieve contacts from your community accounts

You can view the list of community website accounts and select an account to add a contact from the website to your contacts.

- 1 From the Home screen, open the application list and select **Contacts**.
- 2 Select  → **View SNS friends**.
- 3 Select an account.
- 4 Select contacts → **Done**.

› Create a group of contacts

- 1 From the Home screen, open the application list and select **Contacts**.
- 2 Select **Groups** → **+**.
- 3 Enter a name for the group.
- 4 Select **Edit members**.
- 5 Select members from the contact list and select **Done**.
- 6 When you are finished, select **Done**.

Calendar

Learn to create and manage daily, weekly, or monthly events, and set alarms to remind yourself of important events.

› Change the calendar view

- 1 From the Home screen, open the application list and select **Calendar**.
- 2 Select a view mode from the top of the calendar.
 - **Day:** Hourly blocks for one full day
 - **Week:** A list of scheduled appointments for the days in one full week
 - **Month:** Daily blocks for the current month
 - **List:** A list of all scheduled appointments

› Create an event



- 1 From the Home screen, open the application list and select **Calendar**.
- 2 Select **+**.
- 3 Enter the details of the event as required.
- 4 Select **Done**.

› View events

To view today's schedule,

- 1 From the Home screen, open the application list and select **Calendar**.
- 2 Select **Today**.
- 3 Select an event to view its details.

To view events of a specific date,

- 1 From the Home screen, open the application list and select **Calendar**.
- 2 Select a date on the calendar.
To move to a specific day by entering a date manually, select  → **Go to**, enter the date by selecting  or , and select **Set**.
- 3 Select an event to view its details.

› Stop an event alarm

If you set an alarm for a calendar event, the event alarm icon will appear at the specified time.

- 1 Select  on the system bar.
- 2 Select a reminder to view more details about the event.
- 3 To snooze or dismiss the reminder, select **Snooze all** or **Dismiss all**.

Memo







Learn to record important information to save and view at a later date.

› Create a memo

- 1 From the Home screen, open the application list and select **Memo**.
- 2 Select .
- 3 Enter your memo text.
- 4 Select **Done**.

› View memos

- 1 From the Home screen, open the application list and select **Memo**.
- 2 Select a memo to view its details.
To use additional features with a memo, select .

Tool	Function
	Delete the memo.
	Change the background colour of the memo.
	Lock the memo.
	Print the memo using a USB connection or a WLAN connection.
	Upload your memo on community websites.
	Send the memo to others.

Connectivity

PC connections

Learn to connect your device to a PC with a PC data cable in various USB connection modes. By connecting the device to a PC, you can synchronize files with Windows Media Player, transfer data to and from your device directly, and use the Samsung Kies program.

› Connect with Samsung Kies

Ensure that Samsung Kies is installed on your PC. You can download the program from the Samsung website (www.samsung.com/kies).



Samsung Kies will work on both Windows and Macintosh computers.

- 1 Using a PC data cable, connect the multifunction jack on your device to a PC. Samsung Kies will launch automatically.
If Samsung Kies does not launch automatically, double-click the Samsung Kies icon on your PC.
- 2 Copy files from the PC to the device.
Refer to the Samsung Kies help for more information.

› Synchronize with Windows Media Player

Ensure that Windows Media Player is installed on your PC.

- 1 Using the PC data cable, connect the multifunction jack on your device to a PC with Windows Media Player installed.
When connected, a pop-up window will appear on the PC.
- 2 Open Windows Media Player to synchronize music files.

- 3 Edit or enter your device's name in the pop-up window (if necessary).
- 4 Select and drag the music files you want to the sync list.
- 5 Start synchronization.

▶ Connect as a mass storage device

You can connect your device to a PC as a removable disk and access the file directory.



You can use a USB storage device to store additional files. Your device may not support some USB storage devices.

- 1 Using the PC data cable, connect the multifunction jack on your device to a PC.
- 2 Open the folder to view files.
- 3 Copy files from the PC to your device.



To disconnect the device from the PC, click the USB device icon on the Windows task bar and click the option to safely remove the mass storage device. Then remove the PC data cable from the PC. Otherwise, you may lose data stored on your device or damage your device.



Ensure that USB debugging is turned off in **Settings** → **Applications** → **Development** or this procedure will not work.

Wi-Fi

Learn to use your device's wireless networking capabilities to activate and connect to any wireless local area network (WLAN) compatible with the IEEE 802.11 a/b/g/n standards. You can connect to the internet or other network devices anywhere an access point or wireless hotspot is available.

› Activate the WLAN feature

1 From the Home screen, open the application list and select **Settings** → **Wireless and networks** → **Wi-Fi settings**.

2 Select **Wi-Fi** to activate the WLAN feature.



An active WLAN running in the background will consume battery power. To preserve battery power, activate the WLAN only when needed.

› Find and connect to a WLAN

1 From the Home screen, open the application list and select **Settings** → **Wireless and networks** → **Wi-Fi settings**.

The device will automatically search for available WLANs.

2 Select a network under **Wi-Fi networks**.

3 Enter a password for the network (if necessary).

4 Select **OK**.

› Add a WLAN manually

1 From the Home screen, open the application list and select **Settings** → **Wireless and networks** → **Wi-Fi settings** → **Add Wi-Fi network**.

2 Enter the SSID for the network and select the security type.

- 3 Set the security settings depending on the selected security type.
- 4 Select **Save**.

Wi-Fi Direct

Wi-Fi Direct allows Wi-Fi devices to talk to each other without the need for wireless access points (hot spots).

 Activating this feature will disconnect your current Wi-Fi network connection.

- 1 From the Home screen, open the application list and select **Settings** → **Wireless and networks** → **Wi-Fi Direct settings**.
- 2 Tap **Wi-Fi Direct**. A check mark displays next to the feature indicating it is enabled. Your phone will search for other devices enabled with Wi-Fi direct connections.
- 3 Tap a device name to begin the connection process. The target device must also have Wi-Fi Direct service activated and running before it can be detected by your device.
- 4 Tap **Connect**. The direct connection is established.
- 5 When prompted to complete the connection, tap **OK**. The status field now reads “Connected” and the connected device is shown within the Wi-Fi Direct devices listing.

Bluetooth

Bluetooth is a short-range wireless communications technology capable of exchanging information over a distance of about 10 m without requiring a physical connection.

You do not need to line up the devices to beam information with Bluetooth. If the devices are within range of one another,

you can exchange information between them even if they are located in different rooms.



- Samsung is not responsible for the loss, interception, or misuse of data sent or received via the Bluetooth wireless feature.
- Always ensure that you share and receive data with devices that are trusted and properly secured. If there are obstacles between the devices, the operating distance may be reduced.
- Some devices, especially those that are not tested or approved by Bluetooth SIG, may be incompatible with your device.

› Turn on the Bluetooth wireless feature

- 1 From the Home screen, open the application list and select **Settings** → **Wireless and networks** → **Bluetooth settings**.
- 2 Select **Bluetooth** to turn on the Bluetooth wireless feature.

› Find and pair with other Bluetooth-enabled devices

- 1 From the Home screen, open the application list and select **Settings** → **Wireless and networks** → **Bluetooth settings** → **scan for nearby devices**.
- 2 Select a device.
- 3 Enter a PIN for the Bluetooth wireless feature or the other device's Bluetooth PIN, if it has one, and select **OK**. Alternatively, select **Accept** to match the PIN between your device and the device.

When the owner of the other device enters the same PIN or accepts the connection, pairing is complete. If the pairing is successful, the device will automatically search

for available services.



Some devices, especially headsets or hands-free car kits, may have a fixed Bluetooth PIN, such as 0000. If the other device has a PIN, you must enter it.

➤ Send data using the Bluetooth wireless feature

1 Select a file or item, such as a contact, calendar event, or media file, from an appropriate application.

2 Select an option for sending data via Bluetooth.



The method for selecting an option may vary by data type.

3 Search for and pair with a Bluetooth-enabled device.

➤ Receive data using the Bluetooth wireless feature

1 From the Home screen, open the application list and select **Settings** → **Wireless and networks** → **Bluetooth settings** → **Visible**.

2 When prompted, enter the PIN for the Bluetooth wireless feature and select **OK** (if necessary).

3 Select  on the system bar and select **Accept** to confirm that you are willing to receive data from the device.

Received data is saved to the bluetooth folder. If you receive a contact file, select **Settings** → **Wireless and networks** → **Bluetooth settings** → **Show received files** → a contact file to import it to your phonebook.

GPS

Your device is equipped with a global positioning system (GPS) receiver. Learn to activate location services.

To receive better GPS signals, avoid using your device in the following conditions:

- between buildings, in tunnels or underground passages, or inside buildings
- in poor weather
- around high voltage or electromagnetic fields
- in a vehicle with sun protection film

 Do not touch the internal antenna area or cover this area with your hands or other objects while using the GPS functions.

 This feature may be unavailable depending on your region or service provider.

▶ Activate location services

You must activate location services to receive location information and search the map.

- 1 From the Home screen, open the application list and select **Settings** → **Location and security**.
- 2 Adjust the following settings to activate location services:

Option	Function
Use wireless networks	Set to use WLAN and/or mobile networks for finding your location.
Use GPS satellites	Set to use the GPS satellite for finding your location.
Use location for Google Search	Set the device to use your current location for Google search and other Google services.

VPN connections

You can create virtual private networks (VPN) and connect to your private network securely through a public network, such as the internet.

 Your device should already be configured with internet access. If you have trouble accessing the internet, you need to edit connections. If you are not sure about the connection information to enter, ask your service provider.

› Set up VPN connections

1 From the Home screen, open the application list and select **Settings** → **Wireless and networks** → **VPN settings** → **Add VPN**.

2 Select a VPN type.

3 Customize the connection information.

 Available options may vary depending on the VPN type.

Option	Function
VPN name	Enter a name of the VPN server.
Set VPN server	Enter the IP address of the VPN server.
Enable Encryption	Set to encrypt the VPN server.
Set IPsec pre-shared key	Enter a pre-shared key.
Enable L2TP secret	Set to use the L2TP secret password.
Set L2TP security	Enter the L2TP secret password.

Option	Function
Set user certificate	Select a user certificate that the VPN server uses to identify you. You can import certificates from the VPN server or download from the web.
Set CA certificate	Select a certificate authority (CA) certificate that the VPN server uses to identify you. You can import certificates from the VPN server or download from the web.
DNS search domains	Enter the domain name server (DNS) address.

4 When you are finished, select  → **Save**.

▶ Connect to a private network

- 1 From the Home screen, open the application list and select **Settings** → **Wireless and networks** → **VPN settings**.
- 2 Select a private network to connect.
- 3 Enter the user name and password and select **Connect**.

Settings

Access the Settings menu

- 1 From the Home screen, open the application list and select **Settings**.
- 2 Select a setting category and select an option.

Wireless and networks

Change the settings for wireless network connections.

› Flight mode

Disable all wireless functions on your device. You can use only non-network services.

› Wi-Fi

Turn the WLAN feature on or off.

› Wi-Fi settings

- **Wi-Fi:** Turn the WLAN feature on or off. ► p. 70
- **Network notification:** Set the device to notify you when an open network is available.
- **Wi-Fi sleep policy:** Set when the device will turn off the WLAN feature.
- **Add Wi-Fi network:** Add WLAN APs manually.

› Wi-Fi Direct settings

- **Wi-Fi Direct:** Turn Wi-Fi Direct on or off.
- **Device name:** displays the default device name and lets you change the name.
- **Status:** Displays connection status (Connected/Disconnected).
- **Disconnect Wi-Fi Direct:** disconnects the connection.

› Kies via Wi-Fi

Connect your device to Samsung Kies via a WLAN.

› Bluetooth

Turn the Bluetooth wireless feature on or off. **Bluetooth settings**

- **Bluetooth:** Turn the Bluetooth wireless feature on or off.
▶ p. 71
- **Device name:** Set a Bluetooth name for your device.
- **Visible:** Set your device to be visible to other Bluetooth devices.
- **Visible timeout:** Set duration that your device is visible.
- **Show received files:** View files received from other devices via the Bluetooth wireless feature.
- **Scan for nearby devices:** Search for available Bluetooth devices.

› Tethering and portable hotspot

Share your device's mobile data connection via USB or Bluetooth, or turn it into a portable Wi-Fi hotspot. Select **Help** for more information.

› VPN settings

Set up and connect to virtual private networks (VPNs). ▶ p. 75

› Mobile networks

Set options for roaming, networks and APNs.

- **Data enabled:** Enable data access over the Mobile network.
- **Data roaming:** Allows you to connect to your service provider's partner networks and access data services when you are out of your service provider's area of coverage.
- **Access Point Names:** Change your network access point settings.

- **Network Mode:** Select the type of network access your tablet will use (GSM/WCDMA/LTE(Auto mode), GSM/WCDMA(Auto mode), LTE only, WCDMA only, GSM only).
- **Network operators:** Manually select a network operator or set the network selection to Automatic..



- You must deactivate data service prior to searching for an available network.
- Connecting to 2G networks slows the data transfer speed and time.

Sound

Change the settings for various sounds on your device.

- **Vibrate:** Set when the device will vibrate for various events.
- **Volume:** Adjust the volume level for notifications (🔊), media sounds (🔊), alarm ringtones (🔊), and system sounds (🔊).
- **Notification ringtone:** Select a ringtone to alert you to events.
- **Audible selection:** Set the device to sound when you select an application or option on the touch screen.
- **Screen lock sounds:** Set the device to sound when you lock or unlock the touch screen.
- **Haptic feedback:** Set the device to vibrate when you touch the keys.
- **Vibration intensity:** Adjust the vibration intensity of the haptic feedback.

Screen

Change the settings for the display.

- **Brightness:** Set the brightness of the display.
- **Screen display:**
 - **Font style:** Change the font type for the display text. You can download fonts from Android Market by selecting

Get fonts online.

- **Wallpaper:** Select a background image for the Home screen.
- **Wallpaper:** Select an image to display when the screen is locked.
- **Mode:** Select a display mode.
- **Auto-rotate screen:** Set whether or not to rotate the content automatically when the device is rotated.
- **Animation:** Set the device to display animation when you switch between windows.
- **Timeout:** Set the length of time the device waits before turning off the display's backlight.
- **Auto adjust screen power:** Set to save power by adjusting the brightness of the display.
- **Gyro sensor calibration:** uses the built-in gyroscope to calibrate motion.

Power saving mode

- **Use power saving mode:** Automatically activate Power saving mode when the battery is low.
- **Power saving mode on:** Select a power level for power saving mode to turn on.
- **Turn off Wi-Fi:** Deactivate the WLAN feature when the device is not connected with a WLAN AP.
- **Turn off Bluetooth:** Deactivate the Bluetooth feature when not in use.
- **Turn off GPS:** Deactivate the GPS feature when not in use.
- **Turn off Sync:** Turn off sync when the device is not synchronizing with a web server.
- **Brightness:** Allow brightness adjustment in power saving mode.
- **Brightness:** Set the brightness level for power saving mode.
- **Timeout:** Set the length of time the device waits before

turning off the display's backlight.

- **Power saving tips:** Learn how to reduce battery consumption.

Location and security

Change the settings for securing your device and GPS functionality.

- **Use wireless networks:** Set to use WLANs for finding your location.
- **Use GPS satellites:** Set to use PS satellites for finding your location.
- **Use location for Google Search:** Set the device to use your current location for Google search and other Google services.
- **Configure lock screen:** Set how to unlock the screen.
 - **Off:** Disable the screen lock.
 - **Unsecure:** Set to use the screen lock without a PIN, password, or pattern.
 - **Pattern:** Set an unlock pattern to unlock the screen.
 - **PIN:** Set a PIN (numeric) to unlock the screen.
 - **Password:** Set a password (alphanumeric) to unlock the screen.
- **Owner information:** Edit the text you want to display on the screen in Screen lock mode.
- **Encrypt device:** Set a PIN or a password to encrypt the device to protect data and information saved on the device. Once the device is encrypted, you must enter the password each time you turn on the device. You must first charge the battery because it may take more than an hour to encrypt your device.
- **SIM change alert:** sends an SMS message when the SIM card is changed.
- **Alert message recipients:** lets you set recipients for SIM change message (requires Samsung account).

- **Remote controls:** Allow device to be locked, tracked and wiped remotely (requires Samsung account).
- **Set up SIM card lock:** Use PIN code to prevent use of your SIM card to make unauthorized calls or unauthorized access to information stored on your SIM card.
- **Visible passwords:** Set the device to display your password as you enter it.
- **Device administrators:** View device administrators installed on your device. You can activate device administrators to apply new policies to your device.
- **Use secure credentials:** Use certificates and credentials to ensure secure use of various applications.
- **Install from storage:** Install encrypted certificates that are stored in the USB storage.
- **Set password:** Create and confirm a password for accessing credentials.
- **Clear storage:** Erase the credential contents from the device and reset the password.

Applications

Change the settings for managing installed applications.

- **Manage applications:** Access the list of the applications installed on the device and check the application information.
- **Running services:** View the services you are using and access them to manage.
- **Memory usage:** View available memory and the memory used by applications.
- **Battery use:** View the amount of power consumed by your device.
- **Unknown sources:** Select to download applications from any source. If you do not select this option, you can download applications only from Android Market.
- **Development:**

- **USB debugging:** Select to use debug mode when you connect your phone to a PC by using a PC data cable. This is used for application development.
- **Stay awake:** Set the device's screen to stay on while charging the battery.
- **Allow mock locations:** Allow mock locations and service information to be sent to a Location Manager service for testing. This is for application development.

Accounts and sync

Change the settings for the auto sync feature or manage accounts for synchronization.

- **Background data:** Select this setting to allow applications sync data at any time.
- **Auto-sync:** Set the device to synchronize contact, calendar, and email data automatically.

Motion settings

Change the settings that control motion recognition on your device.

- **Motion activation:** Set to use motion recognition.
- **Tilt:** Set to zoom in or out while viewing images in Gallery or browsing web pages when you tap and hold two points with your fingers and then tilt the device back and forth.
- **Panning:** Set to move an item to another page when you tap and hold the item and then tilt the device to the left or right.

Firewall

- **Use IP Firewall:** Set to use IP firewall to protect the tablet when using various applications that can access the Web.
- **IP firewall settings:** For each listed application, tap to select **Default policy**, **Allow** or **Block**, then tap **OK**.
- **Default policy settings:** set the default firewall policy to

Allow or **Block**. Tap a selection.

Privacy

- **Back up my data:** Set to back up your settings and application data to the Google server.
- **Backup account:** Add and view your Google account to back up your data.
- **Automatic restore:** Set to restore your settings and application data when the applications are reinstalled on your device.
- **Factory data reset:** Reset your settings to the factory default values and delete all your data.

Storage

Check memory information of your device.

Language and input

Change the settings for text input, voice recognition, and the text-to-speech feature.

› Select language

Select a display language for all menus and applications.

› Voice recognition settings

- **Language:** Select a language for the Google voice recognition.
- **SafeSearch:** Set the device to filter explicit text and/or images from voice search results.
- **Block offensive words:** Hide offensive words your device recognized from voice search results.

› Text-to-speech settings

- **Listen to an example:** Listen to the spoken text for an example. Install voice data for using the text-to-speech feature.
- **Always use my settings:** Set to use the speech rate and language settings you specify over the settings saved in applications.
- **Default engine:** Set the speech synthesis engine to be used for spoken text.
- **Install voice data:** Download and install voice data for the text-to-speech feature.
- **Speech rate:** Select a speed for the text-to-speech feature.
- **Language:** Select a language for the text-to-speech feature.
- **Samsung TTS:** Settings for the Samsung TTS text-to-speech engine.
- **Pico TTS:** Settings for the Pico TTS text-to-speech engine.

› Current input method

View a default keyboard type for text input.

› Input method selector

Set the device to hide or display the text input settings icon (). If you select **Automatic**, your device will automatically hide or display the icon, based on the keyboard.

› Configure input methods

- **Swype:**
 - **Swype:** Set the device to use the Swype keyboard.
 - **Settings:**
 - Language:** Select languages for text input.
 - Audio feedback:** Set to alert you when there are no alternative words for your input if you double-tap a word.
 - Vibrate on keypress:** Set the device to vibrate when you touch a key.
 - Show tips:** turns on an on-screen indicator that provides helpful user information.
 - Word suggestion:** Set the device to display suggestions

while you are entering text. This feature is available only for English.

Auto-spacing: Set the device to automatically insert a space between words.

Auto-capitalization: Set the device to automatically capitalize the first letter after a final punctuation mark, such as a period, question mark, or exclamation mark.

Show complete trace: Set to display the trace of your dragging on the keyboard.

Speed vs. accuracy: Set the balance for the speed and accuracy.

Personal dictionary: lets you add and remove words in your personal dictionary.

Reset Swype's dictionary: Deletes all words you have added to Swype's dictionary.

Swype help: Access help information for using the Swype keyboard.

Tutorial: Learn how to enter text faster with the Swype keyboard.

Version: View version information.

- **Android keyboard:**

- **Android keyboard:** Set the device to use the Android keyboard.

- **Active input methods:** Select languages for text input.

- **Settings:**

- Auto-capitalization:** Set the device to automatically capitalize the first letter after a final punctuation mark, such as a full stop, question mark, or exclamation mark.

- Vibrate on keypress:** Set the device to vibrate when you touch a key.

- Sound on keypress:** Set the device to sound when you touch a key.

- Auto correction:** Set the device to automatically correct misspelled words.

- Show correction suggestions:** Set the device to predict words according to your input and display word

suggestions.

- **Samsung keypad:**

- **Samsung keypad:** Set the device to use the Samsung keyboard.

- **Settings:**

Input language: Select languages for text input.

XT9: Activate XT9 mode to enter text using Predictive input mode.

XT9 advanced settings: Activate the advanced features of XT9 mode, such as auto completion, auto correction, or auto substitution, and set up your own word list.

Automatic full stop: Set the device to insert a period when you double-tap the space bar.

Sound on keypress: Set the device to sound when you touch a key.

Auto-capitalization: Set the device to automatically capitalize the first letter after a final punctuation mark, such as a period, question mark, or exclamation mark.

Voice input: Activate the voice input feature to enter text by voice on the Samsung keypad.

Handwriting settings: view and set handwriting settings, including Recognition time, Pen thickness, Pen colour, Recognition type, Gesture guide, About.

Tutorial: Learn how to enter text using the keypad.

Accessibility

Change the settings for accessibility features.

- **Accessibility:** Activate an accessibility application, such as Talkback or Kickback, which provide voice, melody, or vibration feedback. TalkBack is provided with the tablet, other applications can be downloaded from Market.
- **Accessibility applications:** Select an accessibility application to use (TalkBack or downloaded applications).
- **Download accessibility scripts:** Set to allow downloading of accessibility scripts from Google.

- **Touch and hold delay:** Set the recognition time for touching and holding the screen.

Date and time

Access and alter the following settings to control how time and date are displayed on your device:

- **Automatic date and time:** Set the current date and time using network-provided information.
- **Set date:** Set the current date manually.
- **Set time:** Set the current time manually.
- **Select time zone:** Set your home time zone.
- **Use 24-hour format:** Set to the time to be displayed in 24-hour format.
- **Select date format:** Select a date format.

About device

Access information about your device, check the device's status, and update the device system.

Tools

Alarm Clock



Learn to set and control alarms for important events.

› Set a new alarm

- 1 From the Home screen, open the application list and select **Alarm**.
- 2 Select .
- 3 Set alarm details.
- 4 When you are finished, select **Done**.

› Stop an alarm

When the alarm sounds,

- To stop the alarm, drag  right.
- To repeat the alarm after a specified length of time, drag  left.

› Delete an alarm

- 1 From the Home screen, open the application list and select **Alarm**.
- 2 Select an alarm to delete.
- 3 Select **Delete** → **OK**.



You can delete or deactivate alarms by tapping and holding an alarm and selecting **Deactivate alarm** or **Delete alarm** → **OK**.

Calculator

Learn to perform mathematical calculations directly on your device like a typical hand-held or desktop calculator.

- 1 From the Home screen, open the application list and select **Calculator**.
- 2 Use the keys that correspond to the calculator display to perform basic or scientific calculations.

Downloads

Learn to manage logs of files you have downloaded from the web.





- 1 From the Home screen, open the application list and select **Downloads**.
- 2 Select a download folder.
- 3 To open a downloaded file, select the log.
To delete a log, select the check box and then select .

eBook





Learn to open and read books and PDF files.

› Read books

- 1 From the Home screen, open the application list and select **eBook**.
- 2 Select a book from the bookshelf.
- 3 While reading a book, use the following options:
 - To move pages, drag your finger left or right or tap near the left or right margin of a page.
 - To see the available options, tap the screen.
 - To view the table of contents, bookmarks, or highlights, select .



- To customize the settings for fonts and theme, select .
- To read a book via the text-to-speech feature, select  → **Read**.
- To search for text in the book, select .
- To bookmark the current page, select .
- To add a memo, tap and hold a word and select **Memo** from the pop-up window.



4 Create a drawing with the following tools:

Tool	Function
	Highlight the text.
	Write or draw on the book.
	Erase the drawing.
	Customize the pen and highlight settings.

> Import book files

You can import book files (in epub and pdf format) from the internal memory.

 You can purchase a book via online bookstore by selecting .

- 1 From the Home screen, open the application list and select **eBook**.
- 2 Select  → **Import**.
- 3 Select book files to import and select .

Google Search

You can search for applications and data in your device and specific data on the web.

- 1 From the Home screen, tap the search icon in the top left corner of the screen or open the application list and select **Google Search**.
- 2 Enter one or more words to search for.
To search for information by voice, select .
- 3 Select the item you want to access.

MyFiles

Learn to quickly and easily access all of your images, videos, music, sound clips, and other types of files stored on your device.



› Supported file formats

Type	Format
Image	.bmp, .gif, .ico, .jpg, .svg (SVGT)
Video	.mp4, .3gp, .avi, .flv, .wmv, .asf, .mkv, DivX
Music	.mp3, .ogg, .aac, .wma, .mp4, .m4a



- Some file formats are not supported depending on the software of the device.
- If the file size exceeds the available memory, an error can occur when you open files.
- Avoid locking the device's screen while playing a DivX Video-On-Demand. Each time you lock the screen while playing a DivX Video-On-Demand, one of your available rental counts will be decremented.



› Open a file

- 1 From the Home screen, open the application list and select **MyFiles**.
- 2 To change the folder sort order, select the **Name** drop-down menu and select an option.
- 3 Select a folder.
 - To move up one level in the file directory, select .
 - To move to the top level in the file directory, select .
- 4 Select a file to open.

› Create a folder

- 1 From the Home screen, open the application list and select **MyFiles**.
- 2 Select .
- 3 Enter a name and select **Done**.

› Copy or move files

- 1 From the Home screen, open the application list and select **MyFiles**.
- 2 Select a check box next to folders or files to copy or cut.
- 3 Select  or .
- 4 Locate a folder and select .





› Delete files

- 1 From the Home screen, open the application list and select **MyFiles**.
- 2 Select a check box next to folders or files to delete.
- 3 Select .



Pen memo

Learn to create sketch memos with various tools.

- 1 From the Home screen, open the application list and select **Pen memo**.
- 2 Select .
- 3 Create a drawing memo with the following tools:

Tool	Function
	Enter your memo text.
	Write or draw on the screen.
	Erase the sketch.
	Customize the tool settings.

You can also use the following options:

- To insert a photo, memo, or map, select  → **Insert**.
 - Select  to undo your last action.
 - Select  to redo your last action.
- 4 When you are finished, select **Done**.

Voice Search

Learn to use the voice command feature to dial a number, send a message, or search for locations and information by voice.



 This feature may be unavailable depending on your region or service provider.

- 1 From the Home screen, open the application list and select **Voice Search**.
- 2 Select **Speak now**.

- 3 Say a command into the microphone.
- 4 Select the item's name you want to access.

World Clock

Learn to view the time in another region.

- 1 From the Home screen, open the application list and select **World Clock**.
 - 2 Select .
 - 3 Enter a city name and select a city from the list.
You can select a city in the world map view.
 - 4 Select .
 - 5 To add more world clocks, repeat steps 2-4.
-  To adjust clocks for Daylight Saving Time, tap and hold a clock and select **DST settings**.

Troubleshooting

System Reset

If your device has fatal errors, hangs up, or is frozen and unresponsive, you may need to reset the device to regain functionality.

- Press and hold the Power/Reset/Lock key [⓪] for 8 to 10 seconds.

Android System Recovery

Android System Recovery is used to restore the tablet's system software to the original as-shipped state and delete all user data. Under normal operating conditions you should never need to perform a system recovery.



- If you entered this menu by mistake, use the Volume Up/Down keys to select **reboot system now**, then press the Power/Reset/Lock key. Your tablet will then continue to boot up.

To enter the Android System Recovery mode, follow these steps:

- 1 With the tablet turned off, press the Power/Reset/Lock key and the Volume Up key at the same time until the phone switches on (Volume Up is the right side, closest to the Headset jack).
- 2 When the start-up screen appears, release the Power/Reset/Lock key while continuing to press the Volume Up key.
- 3 Continue to press the Volume Up key for at least 8 seconds, until Recovery mode is launched and the Android System Recovery screen displays the following options:
 - **reboot system now**: this option restarts your tablet without making any changes.

- **apply update from external storage:** this option allows you to apply updates from your memory card to your tablet.
- **wipe data/factory reset:** erases all data from the tablet and resets all settings to factory default values. It does not delete content stored on an inserted microSD card.
- **wipe cache partition:** allows you to delete all cache data such as log files.

4 Release the Volume Up key.

5 Use the Volume Up/Down keys to scroll to **wipe data/factory reset**, then press the Power/Reset/Lock key to select the option.

Your device displays network or service error messages

- When you are in areas with weak signals or poor reception, you may lose reception. Move to another area and try again.
- You cannot access some options without a subscription. Contact your service provider for more details.

The touch screen responds slowly or improperly

If your device has a touch screen and the touch screen is not responding properly, try the following:

- Remove any protective covers from the touch screen. Protective covers may prevent the device from recognizing your inputs and are not recommended for touch screen devices.
- Ensure that your hands are clean and dry when tapping the touch screen.
- Restart your device to clear any temporary software bugs.
- Ensure that your device software is upgraded to the latest version.
- If the touch screen is scratched or damaged, take it to your local Samsung Service Centre.

Your device freezes or has fatal errors

If your device freezes or hangs, you may need to close programs or reset the device to regain functionality. If your device is frozen and unresponsive, press and hold [⏻] for 8-10 seconds. The device will reboot automatically.

If this does not solve the problem, perform a factory data reset. From the Home screen, open the application list and select **Settings** → **Privacy** → **Factory data reset** → **Reset device** → **Erase everything**.

The device beeps and the battery icon flashes

Your battery is low. Recharge the battery to continue using the device.

The battery does not charge properly or the device turns off

If the battery will no longer charge completely, you need to replace it with a new battery. Take your device to your local Samsung Service Centre.

Your device is hot to the touch

When you use applications that require more power or use applications on your device for an extended period of time, your device may feel hot to the touch. This is normal and should not affect your device's lifespan or performance.

Error messages appear when launching the camera

Your Samsung mobile device must have sufficient available memory and battery power to operate the camera application. If you receive error messages when launching the camera, try the following:

- Charge the battery.
- Free some memory by transferring files to a PC or deleting files from your device.
- Restart the device. If you are still having trouble with the camera application after trying these tips, contact a Samsung Service Centre.

Error messages appear when opening music files

Some music files may not play on your Samsung mobile device for a variety of reasons. If you receive error messages when opening music files on your device, try the following:

- Free some memory by transferring files to a PC or deleting files from your device.
- Ensure that the music file is not Digital Rights Management (DRM)-protected. If the file is DRM-protected, ensure that you have the appropriate license or key to play the file.
- Ensure that your device supports the file type.

Another Bluetooth device is not located

- Ensure that the Bluetooth wireless feature is activated on your device.
- Ensure that the Bluetooth wireless feature is activated on the device you wish to connect to, if necessary.
- Ensure that your device and the other Bluetooth device are within the maximum Bluetooth range (10 m).

If the tips above do not solve the problem, contact a Samsung Service Centre.

A connection is not established when you connect the device to a PC

- Ensure that the PC data cable you are using is compatible with your device.
- Ensure that you have the proper drivers installed and updated on your PC.

Safety precautions

To prevent injury to yourself and others or damage to your device, read all of the following information before using your device.

Warning: Prevent electric shock, fire, and explosion

Do not use damaged power cords or plugs, or loose electrical sockets

Do not touch the power cord with wet hands, or disconnect the charger by pulling on the cord

Do not bend or damage the power cord

Do not use your device while charging or touch your device with wet hands

Do not short-circuit the charger or the battery

Do not drop or cause an impact to the charger or the battery

Do not charge the battery with chargers that are not approved by the manufacturer

Do not use your device during a thunderstorm

Your device may malfunction and your risk of electric shock is increased.

Do not handle a damaged or leaking Lithium Ion (Li-Ion) battery

For safe disposal of your Li-Ion batteries, contact your nearest authorized service centre.

Handle and dispose of batteries and chargers with care

- Use only Samsung-approved batteries and chargers specifically designed for your device. Incompatible batteries and chargers can cause serious injuries or damage to your device.
- Never dispose of batteries or devices in a fire. Follow all local regulations when disposing of used batteries or devices.

- Never place batteries or devices on or in heating devices, such as microwave ovens, stoves, or radiators. Batteries may explode when overheated.
- Never crush or puncture the battery. Avoid exposing the battery to high external pressure, which can lead to an internal short circuit and overheating.

Protect the device, batteries, and chargers from damage

- Avoid exposing your device and batteries to very cold or very hot temperatures.
- Extreme temperatures can cause the deformation of the device and reduce the charging capacity and life of your device and batteries.
- Prevent batteries from contacting metal objects, as this can create a connection between the + and – terminals of your batteries and lead to temporary or permanent battery damage.
- Never use a damaged charger or battery.

Caution: Follow all safety warnings and regulations when using your device in restricted areas

Turn off your device where prohibited

Comply with all regulations that restrict the use of a mobile device in a particular area.

Do not use your device near other electronic devices

Most electronic devices use radio frequency signals. Your device may interfere with other electronic devices.

Do not use your device near a pacemaker

- Avoid using your device within a 15 cm range of a pacemaker if possible, as your device can interfere with the pacemaker.
- If you must use your device, keep at least 15 cm away from the pacemaker.
- To minimize the possible interference with a pacemaker, use your device on the opposite side of your body from the pacemaker.

Do not use your device in a hospital or near medical equipment that can be interfered with by radio frequency

If you personally use any medical equipment, contact the manufacturer of the equipment to ensure the safety of your equipment from radio frequency.

If you are using a hearing aid, contact the manufacturer for information about radio interference

Some hearing aids may be interfered with by the radio frequency of your device. Contact the manufacturer to ensure the safety of your hearing aid.

Turn off the device in potentially explosive environments

- Always comply with regulations, instructions and signs in potentially explosive environments.
- Do not use your device at refuelling points (service stations), near fuels or chemicals, and at blasting areas.
- Do not store or carry flammable liquids, gases, or explosive materials in the same compartment as the device, its parts, or accessories.

Turn off your device when in an aircraft

Using your device in an aircraft is illegal. Your device may interfere with the electronic navigation instruments of the aircraft.

Electronic devices in a motor vehicle may malfunction due to the radio frequency of your device

Electronic devices in your car may malfunction due to radio frequency of your device. Contact the manufacturer for more information.

Proper care and use of your mobile device

Keep your device dry

- Humidity and all types of liquids may damage device parts or electronic circuits.
- When wet, turn off your device. Dry your device with a towel and take it to a service centre.
- Liquids will change the colour of the label that indicates water damage inside the device. Water damage to your device can void your manufacturer's warranty.

Do not use or store your device in dusty, dirty areas

Dust can cause your device to malfunction.

Do not store your device on slopes

If your device falls, it can be damaged.

Do not store your device in hot or cold areas. Use your device at -20 °C to 45 °C

- Your device can explode if left inside a closed vehicle, as the inside temperature can reach up to 80 °C.
- Do not expose your device to direct sunlight for extended periods of time (such as on the dashboard of a car).
- Store the battery at -20 °C to 45 °C.

Do not store your device with such metal objects as coins, keys and necklaces

- Your device may become deformed or malfunction.
- If the battery terminals are in contact with metal objects, it may cause a fire.

Do not store your device near magnetic fields

- Your device may malfunction or the battery may discharge from exposure to magnetic fields.
- Magnetic stripe cards, including credit cards, phone cards, passbooks, and boarding passes, may be damaged by magnetic fields.
- Do not use carrying cases or accessories with magnetic closures or allow your device to come in contact with magnetic fields for extended periods of time.

Do not store your device near or in heaters, microwaves, hot cooking equipment, or high pressure containers

- The battery may leak.
- Your device may overheat and cause a fire.

Do not drop your device or cause impacts to your device

- The screen of your device may be damaged.
- If bent or deformed, your device may be damaged or parts may malfunction.

Do not use a flash close to the eyes of people or animals

Using a flash close to the eyes may cause temporary loss of vision or damage to the eyes.

Ensure maximum battery and charger life

- Avoid charging batteries for more than a week, as overcharging may shorten battery life.
- Over time, unused batteries will discharge and must be recharged before use.
- Disconnect chargers from power sources when not in use.
- Use batteries only for their intended purposes.

Use manufacturer-approved batteries, chargers, accessories and supplies

- Using generic batteries or chargers may shorten the life of your device or cause the device to malfunction.
- Samsung cannot be responsible for the user's safety when using accessories or supplies that are not approved by Samsung.

Do not bite or suck on the device or the battery

- Doing so may damage the device or cause explosion.
- If children use the device, make sure that they use the device properly.

When using the device:

- Speak directly into the microphone.
- Avoid contact with your device's internal antenna. Touching the antenna may cause the device to transmit more radio frequency than necessary.
- Hold the device with a relaxed grip, press the keys lightly, use special features that reduce the number of keys you have to press (such as predictive text), and take frequent breaks.

Protect your hearing



- Excessive exposure to loud sounds can cause hearing damage.
- Exposure to loud sounds while driving may distract your attention and cause an accident.
- Always turn the volume down before plugging the earphones into an audio source and use only the minimum volume setting necessary to hear your conversation or music.

Use caution when using the device while walking or moving

Always be aware of your surroundings to avoid injury to yourself or others.

Do not carry your device in your back pockets or around your waist

You can be injured or damage the device if you fall.

Do not disassemble, modify, or repair your device

- Any changes or modifications to your device can void your manufacturer's warranty. For service, take your device to a Samsung Service Centre.
- Do not disassemble or puncture the battery, as this can cause explosion or fire.

Do not paint or put stickers on your device

Paint and stickers can clog moving parts and prevent proper operation. If you are allergic to paint or metal parts of the product, you may experience itching, eczema, or swelling of the skin. When this happens, stop using the product and consult your physician.

When cleaning your device:

- Wipe your device or charger with a soft cloth.
- Do not use chemicals or detergents.

Do not use the device if the screen is cracked or broken

Broken glass or acrylic could cause injury to your hands and face. Take the device to a Samsung Service Centre to have it repaired.

Do not use the device for anything other than its intended use

Avoid disturbing others when using the device in public

Do not allow children to use your device

Your device is not a toy. Do not allow children to play with it as they could hurt themselves and others, or damage the device.

Install mobile devices and equipment with caution

- Ensure that any mobile devices or related equipment installed in your vehicle are securely mounted.
- Avoid placing your device and accessories near or in an air bag deployment area. Improperly installed wireless equipment can cause serious injury when air bags inflate rapidly.

Allow only qualified personnel to service your device

Allowing unqualified personnel to service your device may result in damage to your device and will void your manufacturer's warranty.

Be sure to back up important data

Samsung is not responsible for data loss.

Do not distribute copyright-protected material

Do not distribute copyright-protected material that you have recorded to others without the permission of the content owners. Doing this may violate copyright laws. The manufacturer is not liable for any legal issues caused by the user's illegal use of copyrighted material.

UL Certified Travel Adapter

The Travel Adapter for this phone has met applicable UL safety requirements. Please adhere to the following safety instructions per UL guidelines.

FAILURE TO FOLLOW THE INSTRUCTIONS OUTLINED MAY LEAD TO SERIOUS PERSONAL INJURY AND POSSIBLE PROPERTY DAMAGE. IMPORTANT SAFETY INSTRUCTIONS - SAVE THESE INSTRUCTIONS. DANGER - TO REDUCE THE RISK OF FIRE OR ELECTRIC SHOCK, CAREFULLY FOLLOW THESE INSTRUCTIONS. FOR CONNECTION TO A SUPPLY NOT IN NORTH AMERICA, USE AN ATTACHMENT PLUG ADAPTOR OF THE PROPER CONFIGURATION FOR THE POWER OUTLET. THIS POWER UNIT IS INTENDED TO BE CORRECTLY ORIENTATED IN A VERTICAL OR HORIZONTAL OR FLOOR MOUNT POSITION.

Radio frequency safety

The design of your phone complies with updated NCRP standards described below. In 1991-92, the Institute of Electrical and Electronics Engineers (IEEE) and the American National Standards Institute (ANSI) joined in updating ANSI's 1982 standard for safety levels with respect to human exposure to RF signals. More than 120 scientists, engineers and physicians from universities, government health agencies and industries developed this updated standard after reviewing the available body of research. In 1993, the Federal Communications Commission (FCC) adopted this updated standard in a regulation. In August 1996, the FCC adopted hybrid standard consisting of the existing ANSI/IEEE standard and the guidelines published by the National Council of Radiation Protection and Measurements (NCRP).

Acknowledging special precautions and Industry Canada notice

This equipment has been tested and found to comply with the limits of a Class B digital device, pursuant to Part 15 of the FCC Rules. These limits are designed to provide reasonable protection against harmful interference in a residential installation. This equipment generates, uses and can radiate radio frequency energy and, if not installed and used in accordance with the instructions, may cause harmful interference to radio communications. However, there is no guarantee that interference will not occur in a particular installation; if this equipment does cause harmful interference to radio or television reception, which can be determined by turning the equipment off and on, the user is encouraged to try to correct the interference by one or more of the following measures:

- Reorient / relocate the receiving antenna.
- Increase the separation between the equipment and receiver.
- Connect the equipment into an outlet on a circuit different from that to which the receiver is connected.

Consult your dealer or an experienced radio/TV technician for help.

Specific Absorption Rate (SAR)

The SAR is a value that corresponds to the relative amount of RF energy absorbed in the head of a user of a wireless handset.

The SAR value of a wireless device is the result of an extensive testing, measuring and calculation process. It does not represent how much RF the phone emits. All devices are tested at their highest value in strict laboratory settings. But when in operation, the SAR of a device can be substantially less than the level reported to the FCC. This is because of a variety of factors including its proximity to a base station antenna, design and other factors. What is important to remember is that each device meets strict federal guidelines. Variations in SARs do not represent a variation in safety.

All wireless devices must meet the federal standard, which incorporates a substantial margin of safety. SAR values at or below the federal standard of 1.6 W/kg are considered safe for use by the public.

Maximum measured SAR values for the SGH-i957 are:

Cellular/PCS WCDMA/GSM/EDGE: 1.04 W/kg

WLAN: 0.88 W/kg

Correct disposal of this product

The product and its electronic accessories (e.g., charger, headset, USB cable) should not be disposed of with other household waste at the end of their working life. To prevent possible harm to the environment or human health from uncontrolled waste disposal, please separate these items from other types of waste and recycle them responsibly to promote the sustainable reuse of material resources.

This device is compliant with RoHS.

Correct disposal of batteries in this product

The batteries in this product should not be disposed of with other household waste at the end of their working life.

Where marked, the chemical symbols Hg, Cd or Pb indicate that the battery contains mercury, cadmium or lead above reference levels. If batteries are not properly disposed of, these substances can cause harm to human health or the environment.

To protect natural resources and to promote material reuse, please separate batteries from other types of waste and recycle them through your local, free battery return system.

The rechargeable battery incorporated in this product is not user replaceable. For information on its replacement, please contact your service provider.

Disclaimer

Some content and services accessible through this device belong to third parties and are protected by copyright, patent, trademark and/or other intellectual property laws. Such content and services are provided solely for your personal noncommercial use. You may not use any content or services in a manner that has not been authorized by the content owner or service provider. Without limiting the foregoing, unless expressly authorized by the applicable content owner or service provider, you may not modify, copy, republish, upload, post, transmit, translate, sell, create derivative works, exploit, or distribute in any manner or medium any content or services displayed through this device.

“THIRD PARTY CONTENT AND SERVICES ARE PROVIDED “AS IS.” SAMSUNG DOES NOT WARRANT CONTENT OR SERVICES SO PROVIDED, EITHER EXPRESSLY OR IMPLIEDLY, FOR ANY PURPOSE. SAMSUNG EXPRESSLY DISCLAIMS ANY IMPLIED WARRANTIES, INCLUDING BUT NOT LIMITED TO, WARRANTIES OF MERCHANTABILITY OR FITNESS FOR A PARTICULAR PURPOSE. SAMSUNG DOES NOT GUARANTEE THE ACCURACY, VALIDITY, TIMELINESS, LEGALITY, OR COMPLETENESS OF ANY CONTENT OR SERVICE MADE AVAILABLE THROUGH THIS DEVICE AND UNDER NO CIRCUMSTANCES, INCLUDING NEGLIGENCE, SHALL SAMSUNG BE LIABLE, WHETHER IN CONTRACT OR TORT, FOR ANY DIRECT, INDIRECT, INCIDENTAL, SPECIAL OR CONSEQUENTIAL DAMAGES, ATTORNEY FEES, EXPENSES, OR ANY OTHER DAMAGES ARISING OUT OF, OR IN CONNECTION WITH, ANY INFORMATION CONTAINED IN, OR AS A RESULT OF THE USE OF ANY CONTENT OR SERVICE BY YOU OR ANY THIRD PARTY, EVEN IF ADVISED OF THE POSSIBILITY OF SUCH DAMAGES.”

Third party services may be terminated or interrupted at any time, and Samsung makes no representation or warranty that any content or service will remain available for any period of time. Content and services are transmitted by third parties by means of networks and transmission facilities over which Samsung has no control. Without limiting the generality of this disclaimer, Samsung expressly disclaims any responsibility or liability for any interruption or suspension of any content or service made available through this device. Samsung is neither responsible nor liable for customer service related to the content and services. Any question or request for service relating to the content or services should be made directly to the respective content and service providers.

Index

alarms

- creating 89
- deactivating 89
- stopping 89

application list

- accessing 21

battery

- charging 10

Bluetooth

- activating 72
- finding and pairing with devices 72
- receiving data 73
- sending data 73

brightness, display 23

calendar

- creating events 65
- viewing events 66

camera

- capturing photos 51
- customizing camcorder 58
- customizing camera 56
- recording videos 56

connections

- Bluetooth 71
- PC 68
- VPN 75
- WLAN 70, 71

contacts 62

- creating 62
- retrieving 62

device

- customizing 21
- indicator icons 15
- keys 14
- layout 13
- settings 77
- shortcuts panel 20
- turning on or off 12

download manager 90

eBook 90

- importing 91

email

- sending 45
- viewing 46

file manager

- copying or cutting files 93
- deleting files 93
- opening files 93
- supported file formats 92

flight mode 12

gallery

- playing videos 61
- viewing photos 60

Gmail 42

Google Maps 38

Google Search 92

Google Talk 47

home screen

- adding items 19
- moving items 19
- removing items 20

- internet
 - see web browser
- language 84
- market 36
- memos
 - creating 67
 - viewing 67
- messages
 - sending email 45
 - setting email accounts 44
- music hub 51
- music player
 - adding files 49
 - creating playlists 50
 - playing music 49
- PC connections
 - mass storage 69
 - Samsung Kies 68
 - Windows Media Player 68
- phonebook
 - creating contacts 62
 - finding contacts 63
- photos
 - capturing 51
 - capturing by scene 53
 - viewing 60
- Pulse 35
- Samsung Apps 41
- Samsung Kies 68
- settings
 - about tablet 88
 - accessibility 87
 - accounts and sync 83
 - applications 82
 - date and time 88
 - language and input 84
 - location and security 81
 - motion settings 83
 - power saving mode 80
 - privacy 84
 - screen 79
 - sound 79
 - storage 84
 - wireless and networks 77
- silent mode 22
- sketch memo 94
- text input 25
- text memos 67
- time and date, set 22
- touch screen
 - locking 17
 - using 16
- video player 61
- videos
 - capturing 56
 - playing 61
- voice search 94
- VPN connections
 - connecting to 76
 - creating 75
- web browser
 - adding bookmarks 33
 - browsing web pages 31
 - opening multiple pages 33
 - searching for information by

voice 33

WLAN

activating 70

finding and connecting to
networks 70

world clock 95

YouTube 37

uploading videos 37

watching videos 37